

- M 1309.
ONE-SIDED FRAME EXTRUSION
- FOR FABRICS
- FOR WALL FIXING
- FOR SMALL FORMATS (UP TO A0).

- M 1309.
EINSEITIGES RAHMEN-PROFIL
- FÜR STOFFE
- FÜR WANDBEFESTIGUNG
- FÜR KLEINFORMATE (BIS A0).

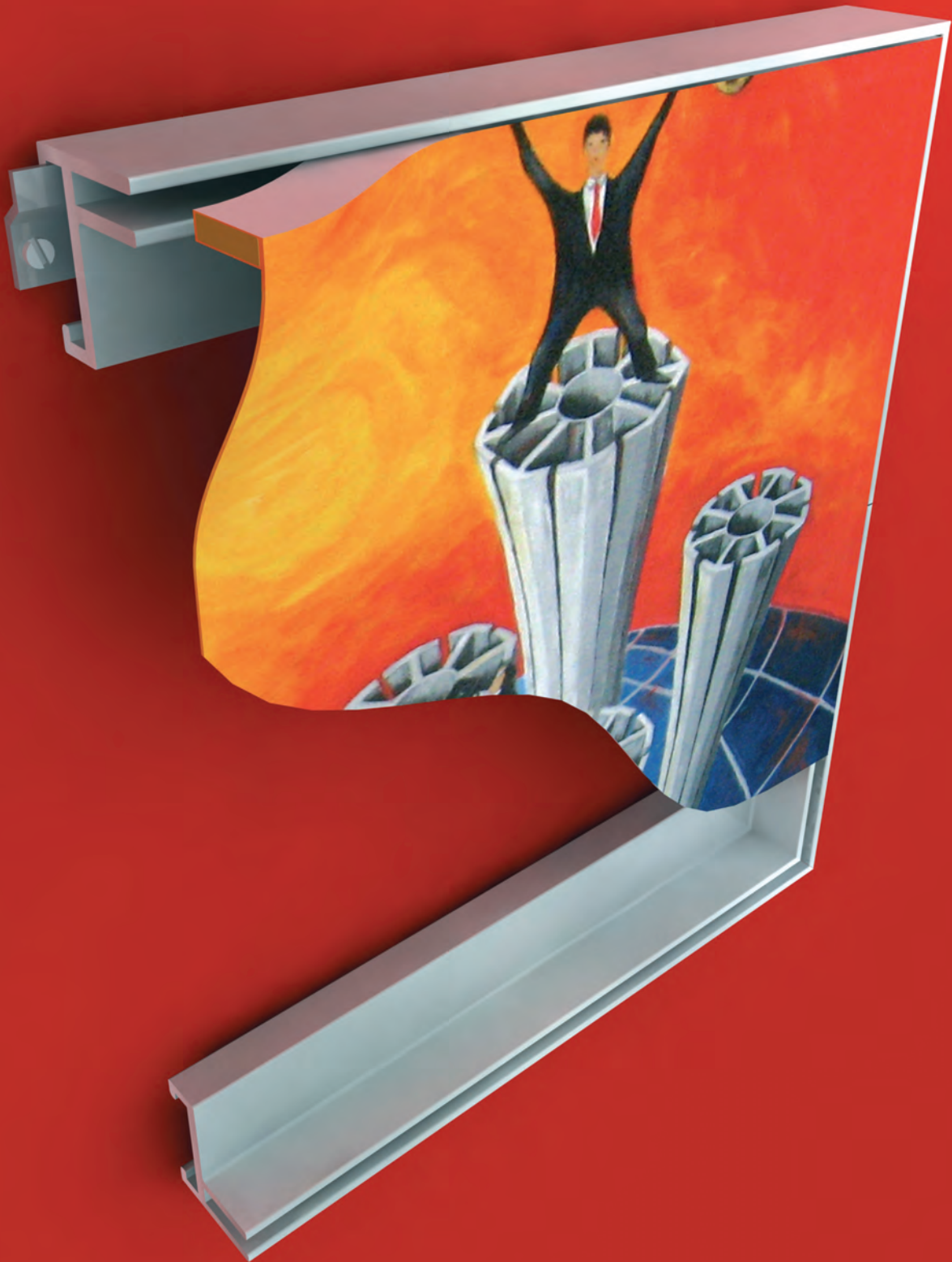

exhibition systems
interior design systems
presentation systems

THE
WORLD
OF
SYSTEMS

OCTANORM 

.PARTS AND
ACCESSORIES.

.BAUTEILE UND
ZUBEHÖR.

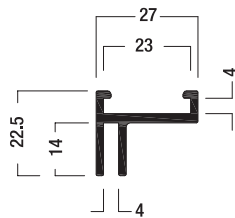

FABRIC FRAME EXTRUSION 22.5 MM
STOFFRAHMEN-PROFIL 22,5 MM

M 1309.01

aluminium
for flush mounting of fabric panels
in connection with a flexible silicone strip M 1313
6000 mm long

Aluminium
für flächenbündigen Einbau von Stoffelementen
in Verbindung mit Silikonkeder M 1313
6000 mm lang

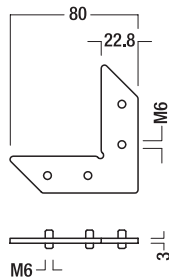
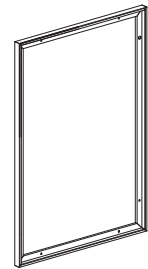

INTERNAL CORNER CONNECTOR
GEHRUNGSWINKEL

M 1335.37

steel
for connecting fabric frame extrusions
M 1302, M 1309 and M 1332
0.132 lbs

Stahl
zum Verbinden von Stoffrahmen-Profilen
M 1302, M 1309 und M 1332
0,060 kg

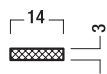
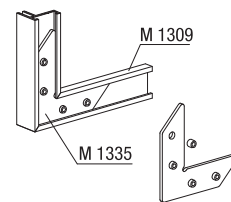

SILICONE STRIP
KEDER

M 1313.50

rubber
for fixing fabrics to extrusion M 1309...
100 m long
5.600 lbs

Gummi
für Stoffbefestigungen an Profile M 1309...
100 m lang
2,540 kg

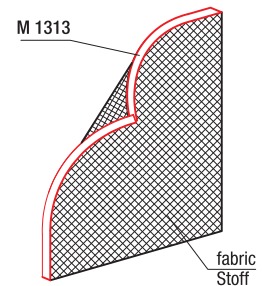

AW 7936_08_2008

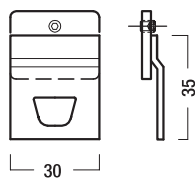

CLAMP FOR FABRIC FRAME EXTRUSION
HALTER FÜR STOFFRAHMEN-PROFIL

M 1434.37

steel
incl. clamping screw M4
0.07 lbs

Stahl
mit Klemmschraube M4
0,03 kg

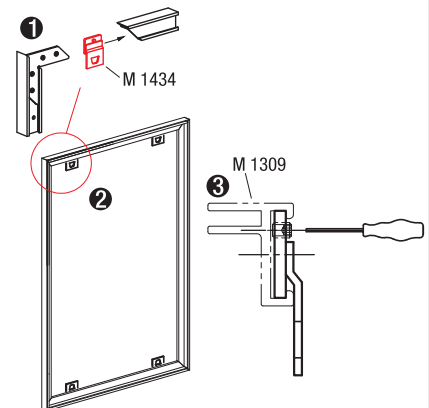

**BRACING OF THE FABRIC FRAME IS NOT POSSIBLE!
KEINE AUSSTEIFUNG MÖGLICH!**

We are pleased to quote for pre-cut and mitred extrusions on request.

Auf Anfrage bieten wir Ihnen gerne auch gesägte und bereits auf Gehrung gefertigte Profile an.

THE
WORLD
OF
SYSTEMS

www.octanorm.com

OCTANORM